

AutoCAD 2012 / AutoCAD LT 2012

2D Mechanical Design

Frede Uhrskov

AutoCAD® 2012
2D Mechanical Design

1. Edition 2011

Copyright© 2011 Uhrskov Publishing

Author: Frede Uhrskov
Teacher College Jelling Seminarium 1971
Odense University 1972
Teacher - Esbjerg Tekniske Skole 1974 - 2005
IT business compagny since 1986
Autorizes AutoCAD forhandler 1991-2003
Member of ADN (Autodesk Developer Network)

3D Studio®
AutoCAD®
Autodesk®
Autodesk, the Autodesk logo,
3D Studio and AutoCAD are registered trademarks
of Autodesk, Inc.
©1995 Autodesk, Inc. All rights reserved

ISBN 978-87-92713-89-6

Uhrskov Publishing

v/Frede Uhrskov
Særmærksvej 46a
6670 Holsted
DENMARK
Mobil: +45 20223395
E-mail: fu@uhrskov.com
<http://www.uhrskov.com>

Preface

The tutorials in this booklet are made for new users in the mechanic area.

The tutorials are made as step-by-step. I have made them in that way because I want the user getting success as soon as possible.

I hope you will enjoy the tutorials and that you will be a better constructor using AutoCAD.

The tutorials are all made in metric.

If you want me to change anything about the tutorials – feel free to contact me at the email below.

frede@uhrskov.com.

Good luck

Denmark 2011

Frede Uhrskov

Directory

Preface	3
Directory	4
Read this first	5
Block of iron	6
The objective of the tutorial	6
Making layers.....	7
Exercise 01 - LAYER.....	7
Template	11
Block of iron	12
Exercise 02 - Line.....	13
Exercise 03 - Line.....	19
Exercise 04 - Copy.....	23
Circles	25
Exercise 05 - Circles.....	26
Center line	28
Exercise 06 - DDIM	28
Fillet	30
Exercise 07 - FILLET.....	31
Chamfer	33
Exercise 08 - CHAMFER.....	34
Exercise 09 - LTSCALE	36
Offset	37
Exercise 10 --OFFSET	38
ZOOM.....	39
Exercise 11 - ZOOM	39
Exercise 12 - TRIM.....	41
Exercise 13 - ERASE	42
Exercise 14 – Change layer	43
Section view	44
Exercise 15 – Polyline	45
Attributes	46
Exercise 16 - Attributes	46
WBLOCK	48
Exercise 17 – Drawing the section line	50
Exercise 18 - INSERT	51
Hatching.....	55
Exercise 19 - HATCH	55
Exercise 20 - TEXT.....	58
Dimension	60
Exercise 21 - DIM	61
Print/Plot	62
Exercise 22 - PLOT.....	62
New Layout.....	69
Rocking link.....	72
Hub for wind mil.....	78

Read this first

It is strongly recommended that:

- AutoCAD is correctly installed
- You use AutoCAD with the standard layout and without any change of the toolbars.
- You know how to make a projected drawing for the mechanical industry.

The layers in the drawing are layers, that I use in my drawing and you can change their names as you like.

Block of iron

The objective of the tutorial

The objective of the tutorial is to make a block as you see below. It is shown isometric, but we will make the drawings in 3 projection planes, so they can be used when you have to make the block in practice.

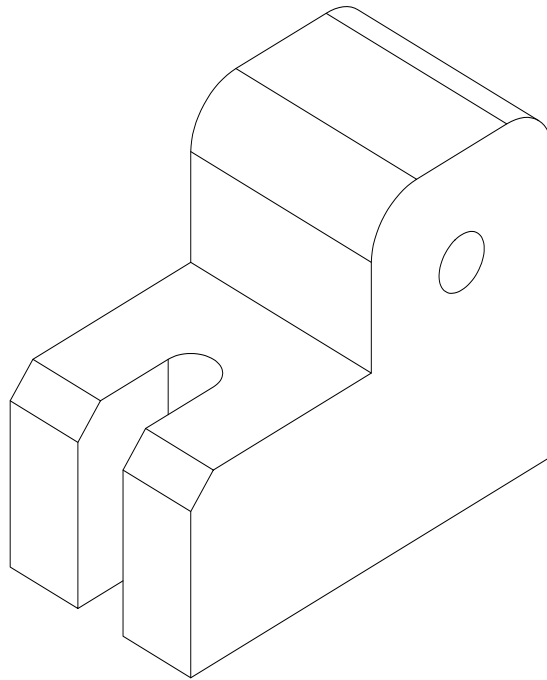

Making layers

Exercise 01 - LAYER

First, you have to make layers with different names - I made the layers showed in this table:

Layers			
Name	Color	Linetype	Lineweight
Frame	Yellow	Continuous	0,5
Midline	Red	Center	0,25
Dimension	Red	Continuous	0,25
Hatch	Green	Continuous	0,25
Hidden line	Green	Hidden	0,25
Section line	Red	Center	0,25
Text	Magenta	Continuous	0,35

You can do it in this way:

- Click the shown button

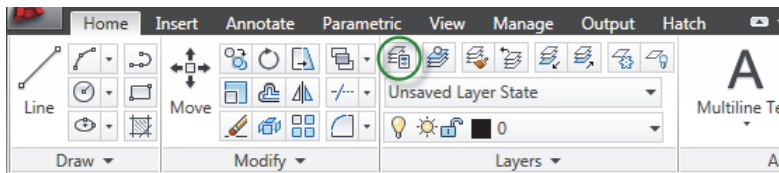

A dialog is shown:

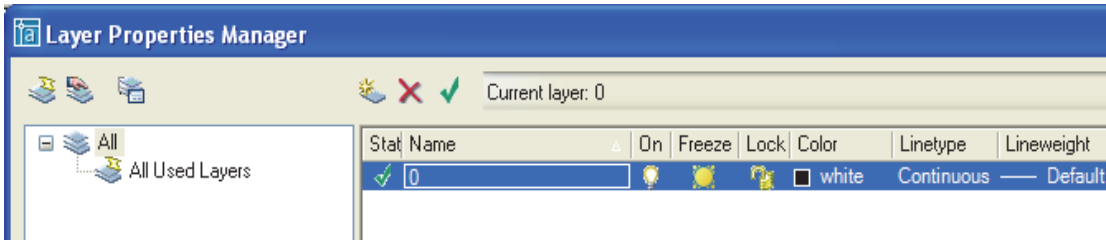

Click New Layer



A new layer called **Layer1** is made

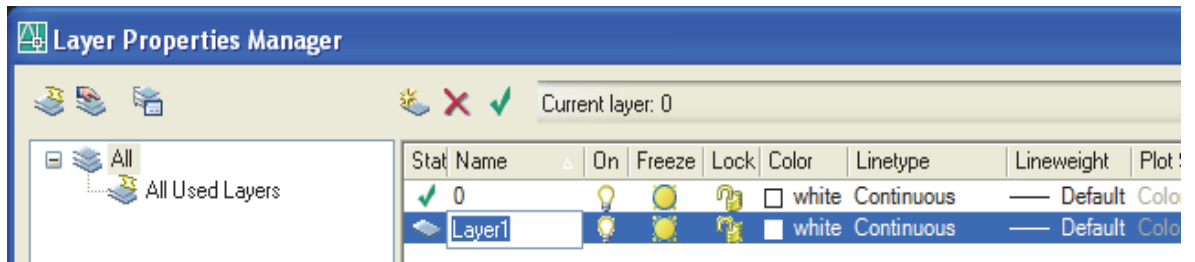

Write the name of the layer in the blue box. Note, that the marked text disappears, when you start writing.

Hit ENTER when you have finished writing the name of the layer.

Change the color of the layer by clicking the name of the color.

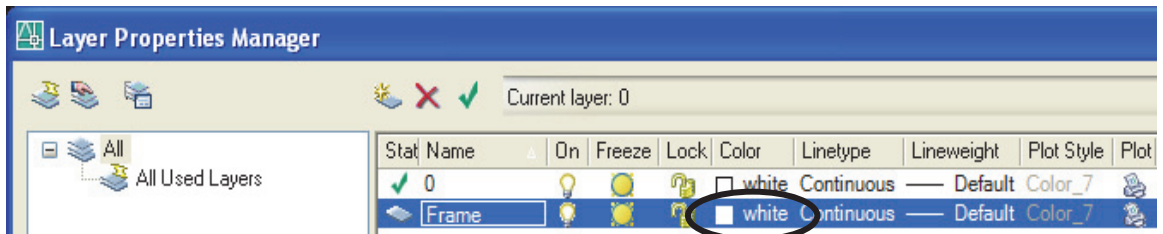

The color dialog shows and you can choose the color you want.

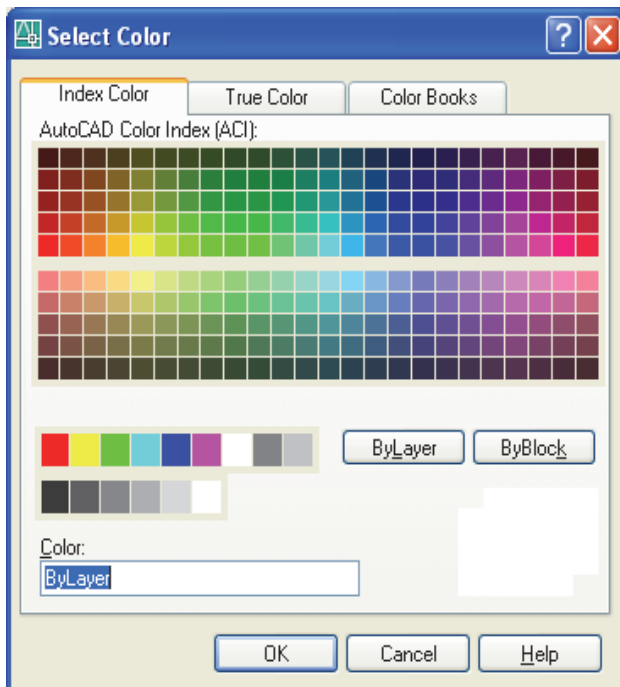

The line type of the layer is set by clicking the name **Continuous**:

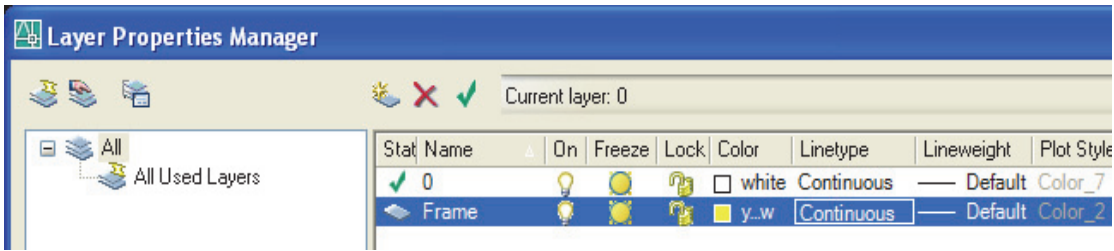

A dialog shows the line types already loaded.

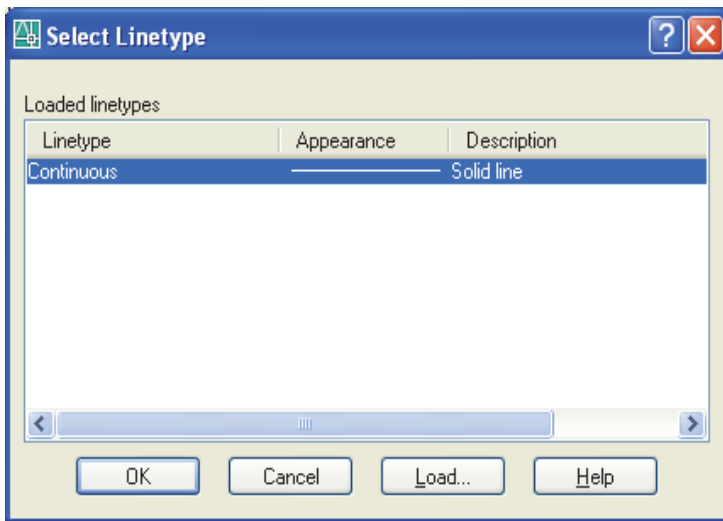

As you can see only one line type is loaded at this time.

The other line types have to be loaded into the drawing.

Click **Load...**

In this dialog you can choose a specific line type or you can choose them all

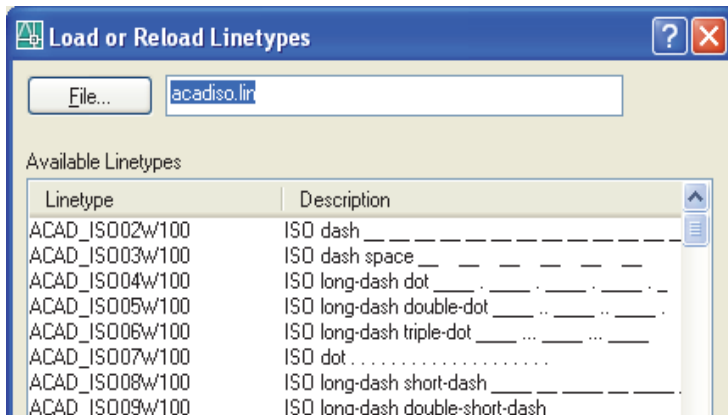

If you want to load all the line types, you can use **Ctrl+A**
All the line types will then be marked and you can hit **OK**

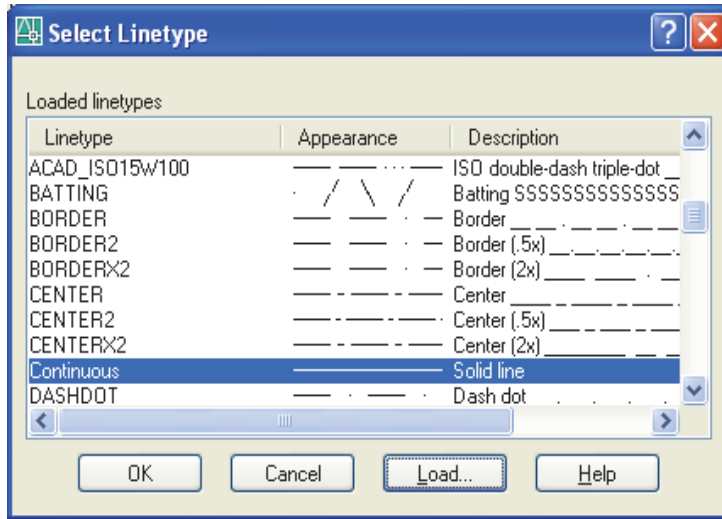

Now you will return to the prior dialog and you can choose the line type that you want for the layer you just created.

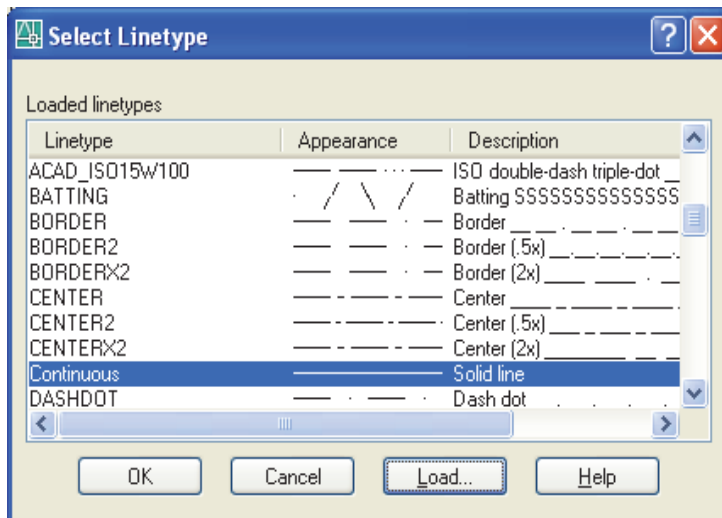

Make the layers in the table and give them the colors and line type as shown.

Template

If you want to reuse the layers, you can save the drawing as a template, which is a standard drawing.

Use the **Save As** and choose the file type DWT see the pictures below.

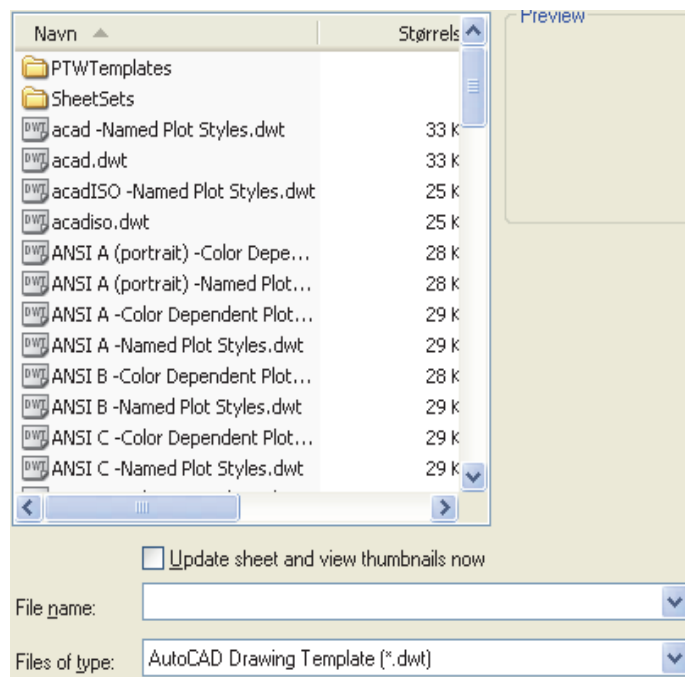
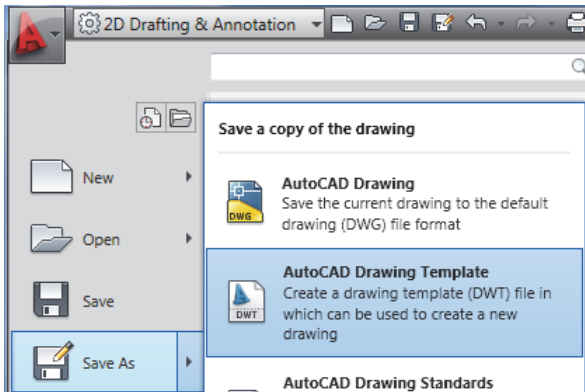

Block of iron

Now we are going to draw a block with a hole, a bend, a chamfer and a milled part.

The drawing should look like this at the end.

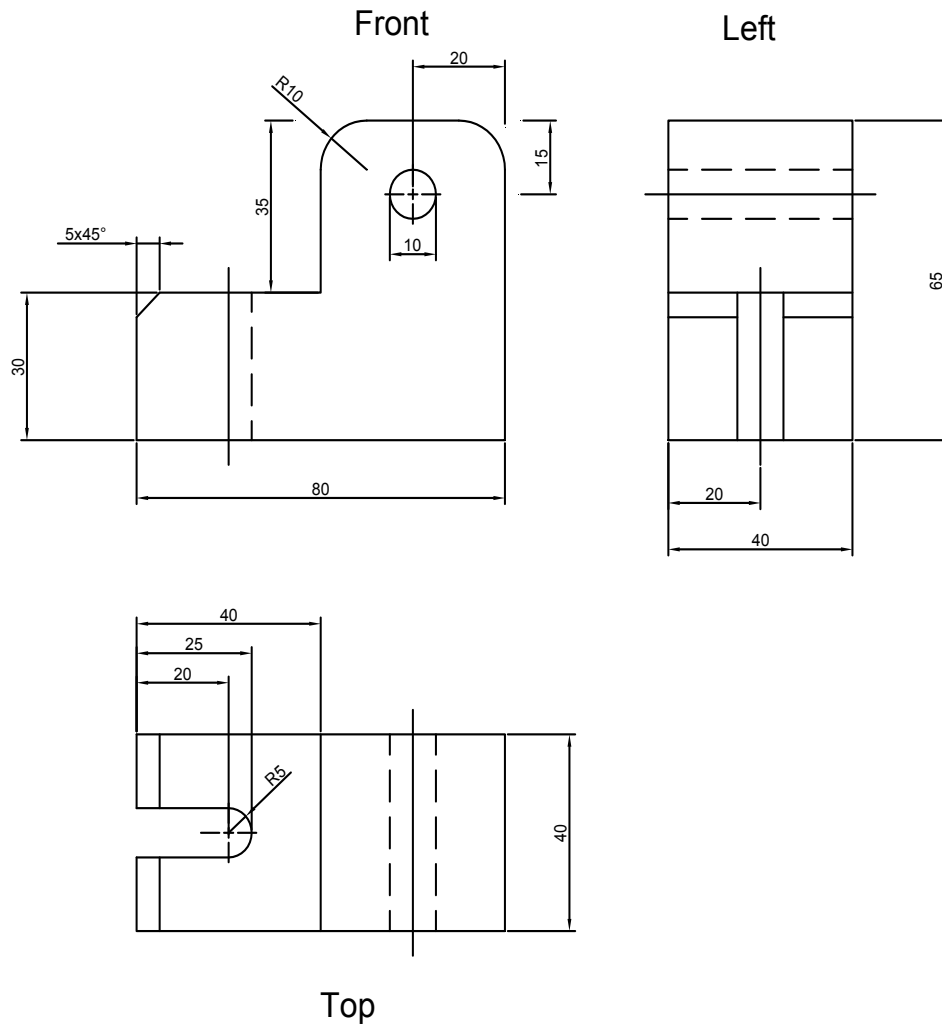

Drawing the frame

Exercise 02 - Line

New layer

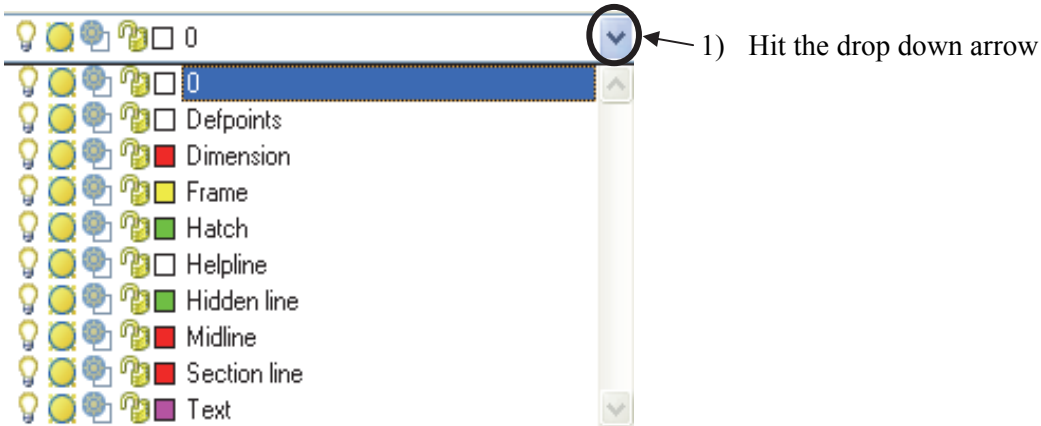

- 2) Choose **Frame**
- 3) Choose **LINE**
- 4) Select a point on the screen, where you want the line to start – that is point 1

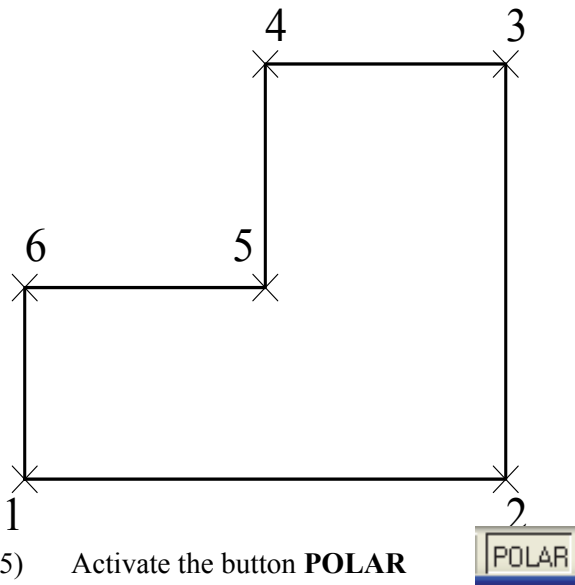

- 5) Activate the button **POLAR**
- 6) Move the cursor in the direction of point 2 – be sure that you see the broken line on the screen. That indicates a horizontal line.

- 7) Type 80 ENTER
- 8) Move the cursor in the direction of point 3
- 9) Type 65 ENTER
- 10) Move the cursor in the direction of point 4
- 11) Type 40 ENTER
- 12) Move the cursor in the direction of point 5
- 13) Type 35 ENTER
- 14) Move the cursor in the direction of point 6
- 15) Type 40 ENTER
- 16) Type C for Close

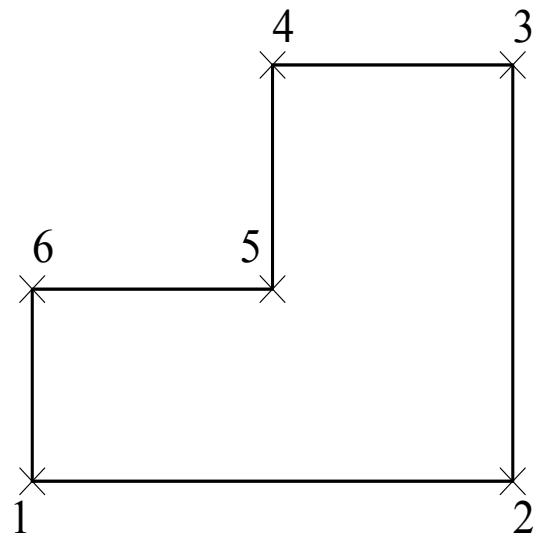

Now you are going to draw the hidden lines.

- 1) Change the layer to **HIDDEN**
- 2) Choose **LINE** (Type L)
- 3) Activate **POLAR** 
- 4) Keep the cursor still on point 1 – don't click
- 5) Move the cursor to the right – be sure that you see the POLAR line
- 6) Type 15 ENTER
- 7) The start point for the next line is now placed 15 mm. from point 1
- 8) Choose OSNAP PERPENDICULAR

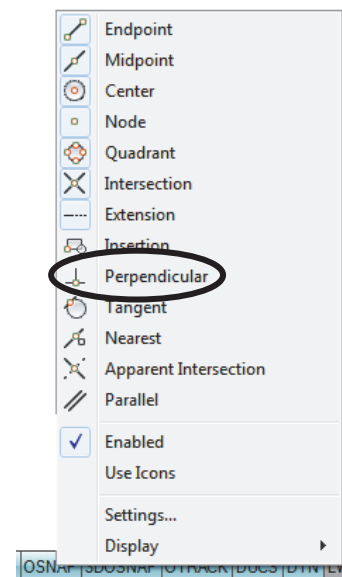

- 9) Click at the opposite line – between point 5 and 6
- 10) Hit ENTER to end drawing the line

Drawing the second hidden line

- 11) Choose LINE
- 12) Keep the cursor still on the endpoint of the first hidden line – don't click
- 13) Move the cursor to the right – be sure that you see the POLAR line
- 14) Type 10 ENTER
- 15) The start point for the second line is now placed 10 mm. from the endpoint of the first hidden line
- 16) Choose OSNAP PERPENDICULAR
- 17) Click at the opposite line – between point 5 and 6
- 18) Hit ENTER to end drawing lines

Drawing the centre line between the 2 hidden lines

In this exercise, we need to change a little in the options of AutoCAD.

1. Choose **OPTIONS** - type in **OP** and ENTER
2. In the Options dialog box mark the shown option:

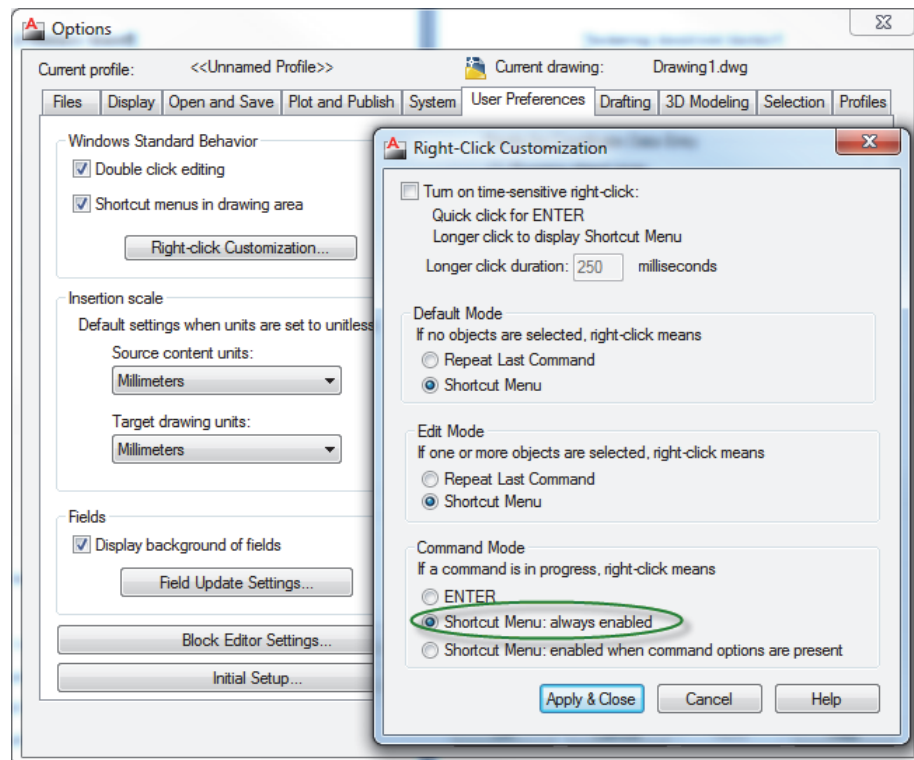

Make the **OTRACK** button inactive

- 1) Change LAYER to MIDLINE
- 2) Choose LINE

Right click and choose **Snap Overrides**

- 3) Choose OSNAP FROM
- 4) Choose OSNAP END

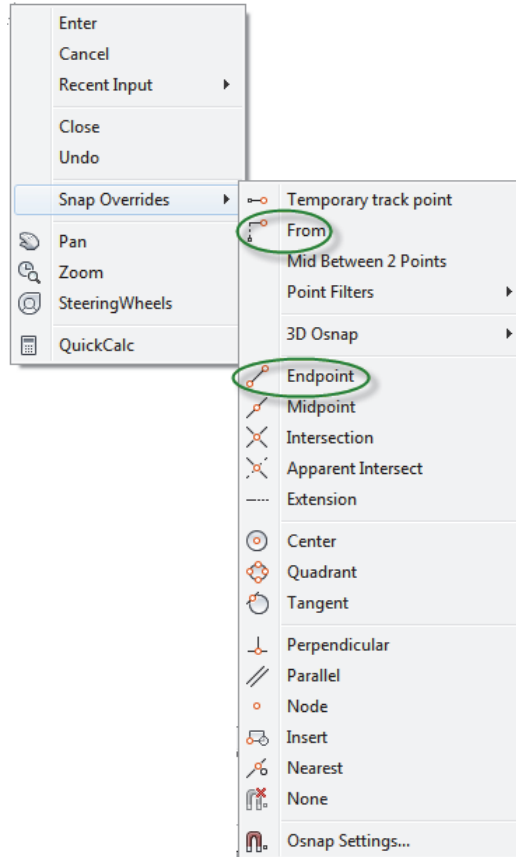

- 5) Pick the lower endpoint of the right hidden line
- 6) Type @-5,-5 ENTER
- 7) The start point of the midline is now placed 5 mm. below the horizontal line
- 8) Move the cursor vertical so you can see the polar line
- 9) Type 40 ENTER - ENTER

The drawing should look like this:

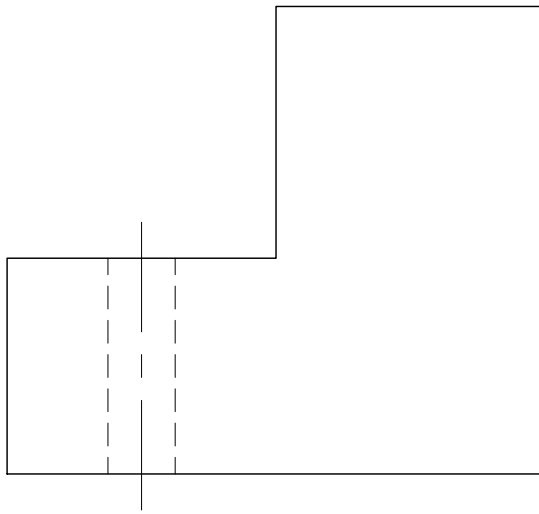

If the HIDDEN lines don't show as hidden you can adjust the spaces between the lines with the command LTSCALE.

Type LTSCALE and set the value to a different value – default is 1 – and you maybe need to try different values before you are satisfied. I prefer a distance about 0.25.

Save the drawing to the disk.